



Inbreeding in Cattle

Sally L. Northcutt
Extension Beef Cattle Breeding Specialist

David S. Buchanan
Professor of Animal Science

Archie C. Clutter
Associate Professor of Animal Science

Oklahoma Cooperative Extension Fact Sheets are also available on our website at: <http://osufacts.okstate.edu>

Inbreeding is the mating of individuals that are related. In the broad sense, all members of a breed are related. As a result, any seedstock producer is practicing some inbreeding. Therefore, we generally reserve the term inbreeding for the mating of animals that are more closely related than the average of the breed.

Genetic and Phenotypic Effects

Inbreeding can have dramatic effects on a herd. These effects are the result of individuals receiving identical genes from each parent. If the parents are related, it is more likely that they have genes that are identical. An individual receiving identical genes from each parent is said to be homozygous for that pair of genes. This would be desirable if the gene the individual received from each parent leads to superior performance. However, most animals carry undesirable genes that usually remain hidden unless the animal is homozygous. An inbred individual is more likely to be homozygous for any gene, so the animal is more likely to express undesirable genes, and hence, undesirable traits.

Inbreeding does not create undesirable recessive genes, but it does tend to bring to light these unfavorable genetics. This leads to a decline in average phenotypic performance called **inbreeding depression**. This phenomenon is well documented in all the major livestock species. Inbreeding depression has the greatest effect on reproductive traits, followed by growth traits, with little or no effect on carcass traits. This pattern is the reverse of the magnitude of heritability for these classes of traits. Inbreeding depression is essentially the opposite effect of heterosis (hybrid vigor), which is the advantage gained from crossing lines or breeds.

Figure 1 illustrates the effect of inbreeding depression on percent open and percent dead at birth. An increase in the inbreeding coefficient results in a change in the performance for the two traits. This change in the percent of open cows as a result of inbreeding would be in addition to the usual percentage open in a non-inbred population. This would also be true for the percentage of calves dead at birth. Other traits in which inbreeding depression has been documented for beef cattle include percentage weaned, birth weight, preweaning gain, weaning weight, postweaning gain, and final weight.

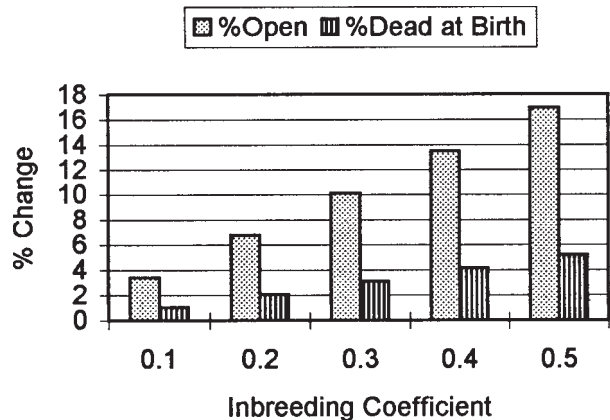

Figure 1. Inbreeding depression for % open and % dead at birth.

Figure 2 illustrates a portion of the pedigrees for two founding bulls for the Shorthorn breed, Favourite (252) and his son Comet (115). Both bulls are inbred. The parents of Comet share common ancestors (Favourite, Phoenix, and Young Strawberry).

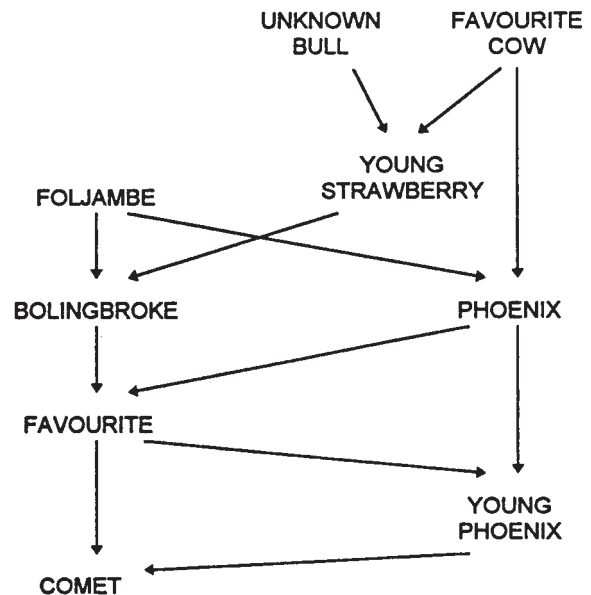

Figure 2. Pedigrees for Favourite (252) and Comet (115).

Foljambe, Favourite Cow) in their known pedigree. The parents of Favourite share common ancestors, Foljambe and Favourite Cow. This diagram is a common format for examining inbreeding. The paths between the sire and dam of the individual of interest are used to calculate the inbreeding coefficient.

Measurement of Inbreeding

Inbreeding of an individual is measured with the **inbreeding coefficient**. The inbreeding coefficient measures the percent increase in homozygous gene pairs in an individual relative to the average of the population from which the individual came. If a bull has an inbreeding coefficient of .25, he is expected to have 25 percent more homozygous gene pairs than a non-inbred individual from the same population.

The inbreeding coefficient can have any value between 0 and 1.0, although it is unlikely for it to have a value much above .5 in most herds of livestock. These coefficients are relative to a particular population. It is fairly easy to have it approach 1.0 in plant species where self-fertilization is possible. Also, some lines of laboratory animals have very high average inbreeding coefficients. A few lines of beef cattle and swine that have undergone intense inbreeding for 40 to 50 years have average inbreeding coefficients of .5 to .6. This is accomplished by many generations of brother-sister or parent-offspring matings; therefore, an inbreeding coefficient over .5 is unlikely in a seedstock herd of beef cattle. The Line 1 Hereford cattle developed at the Montana research station would be an example of an inbred line of cattle.

The general formula for an inbreeding coefficient is as follows:

$$F_x = \sum [(1/2)^{n+1}(1+F_A)]$$

where

F_x = inbreeding coefficient of individual X,

\sum = summation sign, indicating that the values in the brackets are to be added together,

n = number of segregations (arrows) between the sire and dam in each separate path through the common ancestor, and

F_A = inbreeding coefficient of the common ancestor in each separate ancestry path.

A **common ancestor** is an individual that appears on both the sire and dam sides of the pedigree. Whenever a common ancestor is inbred, his/her inbreeding coefficient (F_A) will have to be calculated before the inbreeding coefficient of individual X (F_x) can be determined.

Calculation of an inbreeding coefficient involves several steps:

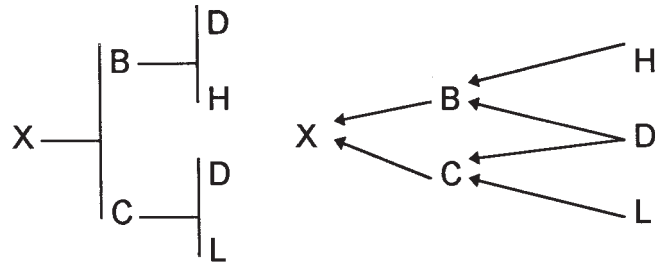

Step 1: Generate an arrow pedigree.



Step 2: List all paths that connect the sire and dam.



Step 3: Locate the common ancestor in each path.

The common ancestor is the individual with the arrows pointing away from it. It is the ancestor that is in the pedigrees of both parents.

Step 4: Determine if the common ancestor in each path is inbred. If so, calculate the inbreeding coefficient for each common ancestor. The rules for determining the inbreeding coefficient of the common ancestor are no different than calculating the inbreeding coefficient of any other individual. If the common ancestor is inbred, simply construct its pedigree and go through each step of the process as if it were the individual of interest.

In this example, the common ancestor is D. Its inbreeding coefficient is assumed to be 0, since neither of its parents are known.

Step 5: Count the number of arrows in each path to determine the value of "n." In this pedigree, there is only one path, and it has two arrows. Therefore, $n=2$.

Step 6: Calculate the value of each path connecting the sire and dam of the individual in question.

$$\begin{aligned} \text{Value of path} &= (1/2)^{n+1}(1+F_A) \\ &= (1/2)^{2+1}(1+0) \quad (F_A = 0 \text{ for common ancestor D}) \\ &= (1/2)^3 = .125 \end{aligned}$$

Step 7: Add together the value for each path connecting the sire and dam of the individual in question.

$$F_x = \sum [(1/2)^{n+1}(1+F_A)] = .125$$

Since there is only one pathway in this example, the inbreeding coefficient of X is .125.

Example 1 illustrates the procedures for computing the inbreeding coefficient for animal Z. In this case, the common ancestor S is inbred. The coefficient F_z is the sum of three pathways from parent S to parent D.

Example 1. Calculate the inbreeding coefficient of animal Z (F_Z).

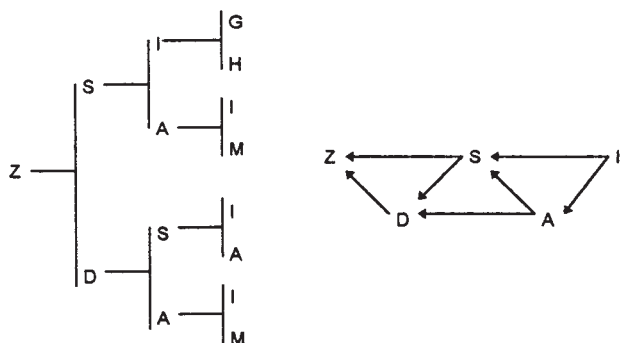

Pathways	Inbreeding of Common Ancestor	n	Value of Path
Ⓢ → D	F _S = .25*	1	$\frac{1}{2}^{1+1}(1+.25) = .3125$
Ⓢ → A → D	F _A = 0	2	$\frac{1}{2}^{2+1}(1+0) = .125$
Ⓢ → I → A → D	F _I = 0	3	$\frac{1}{2}^{3+1}(1+0) = .0625$

$F_z = .3125 + .125 + .0625 = .50$

The inbreeding of individual Z equals the sum of the values of the 3 paths which is .50.

*Inbreeding of S
 Path Ⓢ → A F_I = 0 F_S = $\frac{1}{2}^{1+1}(1+0) = .25$

Inbreeding Systems

The inbreeding systems of half-sib, full-sib and parent-offspring matings are the most severe types of inbreeding that can be practiced with livestock (Examples 2-4).

Example 2. Half-Sibs.

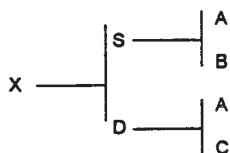

$$F_x = (1/2)^{2+1}(1+0) = .125$$

Individual X resulted from the mating of half-sibs S and D. F_x indicates that X is homozygous for 12.5% of the gene pairs that were heterozygous in ancestors at the foundation to which the pedigree of X was traced.

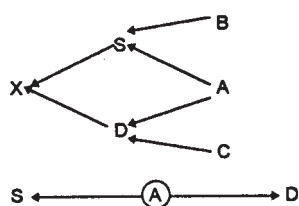

Example 3. Full-Sibs.

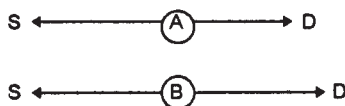
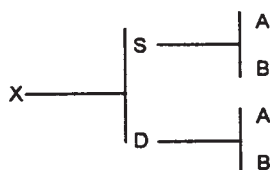

$$F_x = (1/2)^{2+1}(1+0) + (1/2)^{2+1}(1+0) = .25$$

Individual X is 25% inbred and is the result of mating full sibs S and D. F_A and F_B = 0

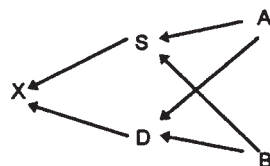

Example 4. Sire-Daughter (parent offspring).

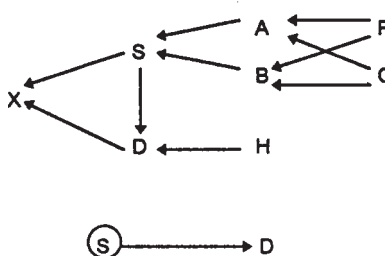

$$F_x = (1/2)^{1+1}(1+.25) = .3125$$

Inbreeding of S contributed to inbreeding of X. If S was non-inbred, F_x would have been .25.

Uses of Inbreeding

Inbreeding can have benefits to a seedstock producer if the breeder understands how to monitor it and is willing to sacrifice some performance in the process. Inbreeding tends to subdivide a breed into families which can be identified and crossed with some small benefit. Sometimes these families will have distinguishing features which will aid in recognition. Creation of families is unlikely to contribute to genetic improvement, but it may aid in merchandising if other members of the family have done well. Certain families may demonstrate superior performance, but if a family group has poor average performance, it should be discarded quickly.

Inbreeding promotes an increase in prepotency, which is the ability of an individual to consistently pass on its characteristics. This prepotency results from the increase in homozygosity. Since an inbred individual will have more homozygous gene pairs than a non-inbred individual, there are fewer possible gene combinations for the sperm or egg cells. As a result, the offspring should be more similar to each other.

Livestock producers may utilize inbreeding in three ways:

- (1) **Critically evaluate an individual.** Critical evaluation of an individual involves testing for the presence of undesirable recessive genes. This process is needed before forming a breeding program around that individual. For example, a planned system of mating may be used to test a sire for an undesirable recessive gene.
- (2) **Develop inbred lines for use in a crossbreeding system.** Lines of genetically different individuals may be developed using inbreeding. Later, the genetically different lines may be used in crosses. Examples of this practice are evident in the seed corn and poultry industries. Producers interested in developing inbred lines should be cautioned. Response achieved by crossing inbred lines is due in part to recovery from inbreeding depression.
- (3) **Concentrate the use of a genetically superior individual (linebreeding).** Linebreeding is a milder form of inbreeding, by maintaining a high degree of relationship between individuals in the pedigree, while having a low level of inbreeding.

Linebreeding

All inbreeding does not result in disaster when the use of inbreeding centers on genetically superior individuals. Linebreeding is probably the best known use of inbreeding. Linebreeding is an attempt to maintain a high relationship to some outstanding ancestor while keeping inbreeding as low as possible. Linebreeding has been attempted in most breeds of cattle. It has the advantage of maintaining genes from outstanding individuals that are no longer available for breeding purposes. Also, it helps in recognition, since the breeder can use the name of the ancestor at the center of linebreeding. This is fine if this ancestor is truly outstanding. Many of the bulls that are the object of linebreeding are probably very good, but this may not be true in all cases. Other dangers associated with linebreeding include the inevitable buildup of inbreeding and the possibility of linebreeding to an inferior son of an outstanding bull.

Example 5 is an illustration of linebreeding. The inbreeding coefficient of X is only .125 (i.e., X is 12.5% inbred). Three generations separate X and Z, but they have a high degree of relationship (about 48% of their genes in common). This degree of relationship is slightly less than that of full-sibs (full-sibs are from the **same** generation and have 50% of their genes in common). Therefore, a high degree of relationship exists between X and Z, but the inbreeding coefficient of X is relatively low.

Linebreeding should be attempted only in superior herds that have difficulty finding outside bulls that are of sufficient merit to improve that herd. The ancestor that is the object of the linebreeding should be clearly outstanding based on performance criteria.

Example 5.

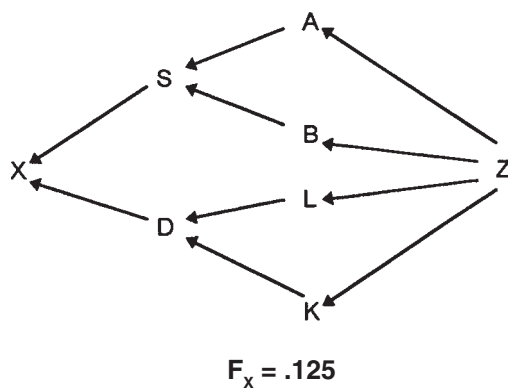

Effect of Inbreeding in a Seedstock Herd

Inbreeding is nearly unavoidable in seedstock herds since it is frequently difficult to find new breeding stock that are not, at least partially, related to animals in an existing herd. Care should be taken to keep inbreeding at a fairly low level by avoiding matings of brothers with sisters or parents with their offspring. Close matings within small herds or family groups not only produce rapid inbreeding buildup and, hence, depression, but can produce random losses of desirable genes.

If inbreeding builds up, the first economic effect will be fewer calves available to sell. In addition, the calves will have poorer performance and will not be as attractive to customers interested in performance.

Genetic improvement in cattle originates in seedstock herds. Inbreeding affects the rate of genetic improvement in several ways. There may be a small increase in prepotency (the degree to which a sire or dam will pass his or her characteristics consistently). This is more than counteracted by the decline in selection intensity and loss of genetic variation. Selection intensity is a function of the proportion of bull and heifer candidates that are actually selected. Selection will be less intense since more bulls and heifers will be needed as replacements, and there will be fewer from which to choose. Furthermore, the variation will be less among the animals since inbreeding reduces intraline genetic variation.

Recommendations

Inbreeding should only be used by seedstock breeders who have a clear understanding of its purpose. Unless approached carefully, the dangers of inbreeding far outweigh the advantages. Perhaps the most important concept to remember about inbreeding is that practicing a high level of inbreeding may result in a decline in average phenotypic merit for various traits. If an animal carries undesirable recessive genes, these genes would be expected to be brought to light by inbreeding practices. Average phenotypic merit would be expected to decline. For example, the decline may impact fertility traits. Results from practicing inbreeding are a function of the genetic merit of the individuals used in the breeding program.

Linebreeding can be an effective tool for perpetuating the genes from an outstanding ancestor. It should be used only in herds that are superior, and only those bulls that are clearly outstanding should be the object of a linebreeding program. Mating of close relatives, such as brothers with sisters or parents with offspring, should be avoided.

Oklahoma State University, in compliance with Title VI and VII of the Civil Rights Act of 1964, Executive Order 11246 as amended, Title IX of the Education Amendments of 1972, Americans with Disabilities Act of 1990, and other federal laws and regulations, does not discriminate on the basis of race, color, national origin, gender, age, religion, disability, or status as a veteran in any of its policies, practices, or procedures. This includes but is not limited to admissions, employment, financial aid, and educational services.

Issued in furtherance of Cooperative Extension work, acts of May 8 and June 30, 1914, in cooperation with the U.S. Department of Agriculture, Robert E. Whitson, Director of Cooperative Extension Service, Oklahoma State University, Stillwater, Oklahoma. This publication is printed and issued by Oklahoma State University as authorized by the Vice President, Dean, and Director of the Division of Agricultural Sciences and Natural Resources and has been prepared and distributed at a cost of 20 cents per copy. 0504